

SPECIFICATION FOR APPROVAL

產品確認書/製品仕様書

| | |
|----------------------|---|
| FILE SERIAL NO./檔序號: | XSG20230717003-T01 |
| CUSTOMER / 客 戶: | |
| ARTICLE / 品 名: | SWITCHING POWER SUPPLY |
| MODEL NO. / 機種型號: | XSG2405000 |
| PARAMETER / 規 格: | 24.0V5.0A |
| CERTIFICATE/認證: | SAA,RCM,CE,CB,PSE,GS,UL,cUL,FCC,LVD,EMC,UKCA,KC |
| ISSUE DATE / 發行日期: | 2023/7/17 |

Please to sign back after you confirm

承認書確認後請回簽一份

この仕様書をご確認とご署名の上、対象の営業窓口にご返信いただきますよう宜しくお願い致します。

| CUSTOMER AUTHORIZED 客戶確認 | | |
|-----------------------------|------------|-------------|
| Approved by | Checked by | Prepared by |
| | | |

| SUPPLIER AUTHORIZED 供方確認 | | |
|-----------------------------|------------|-------------|
| Approved by | Checked by | Prepared by |
| 李麗敏 | 賀子豐 | 張文娟 |

*感謝您的支持，我們十分珍惜每次合作機會

*Thank you for your support,we will treasure the opportunity to cooperate with you

| Rev.版本 | Description of change/ 變更內容描述 | | Changed Date 日期 | Approved |
|--------|-------------------------------|-----------|--------------------|----------|
| | Before(變更前) | After/變更後 | | |
| A | Original Release(初次發行) | | 2023/7/17 | 李麗敏 |
| | | | | |
| | | | | |
| | | | | |
| | | | | |



* Make practical and safe power supply, Be enterprise with honesty and responsibility

* 提供實用安全的電源，做誠信負責的企業

* 実用的、安全な電源を提供し、誠実と信用、責任を持つ企業。

Table of Content(目錄)

| | |
|---|----|
| 1.SAFETY STANDARD / 安規標準 | 3 |
| 2.INPUT FEATURE / 輸入特性 | 3 |
| 3.POWER SUPPLY OUTPUT VOLTAGE/CURRENT FEATURE/供電器輸出電壓/電流的特性 | 3 |
| 4.IELECTRIC WITHSTANDING STRENGTH(HI-POT) / 絕緣介電強度（耐壓） | 4 |
| 5.PROTECTION FEATURE / 保護特性 | 4 |
| 6.ENVIRONMENTAL CONDITIONS / 環境條件 | 4 |
| 7.EMC STANDARDS / 電磁相容性標準 | 5 |
| 8 RELIABILITY AND QUALITY CONTROL / 可靠性及品質控制 | 5 |
| 9.WEIGHT / 重量 | 5 |
| 10.MECHANICAL REQUIREMENT / 結構參數 | 5 |
| 11.INSULATION RESISTANCE / 絕緣阻抗 | 5 |
| 12.LEAKAGE CURRENT / 漏電流 | 6 |
| 13.MAJOR MEASURE EQUIPMENT / 主要測量設備; VERIFIED BY THE THIRD LAB/外校 | 6 |
| 14.DC CORD / 輸出 線材 | 7 |
| 15.AC CORD/輸入線材 | 8 |
| 16.PRODUCT OUTLINE DIMENSION / 產品外觀尺寸 | 9 |
| 17.RATING LABEL / 銘牌 | 10 |
| | |
| | |
| | |
| | |
| | |
| | |
| | |
| | |
| | |
| | |
| | |
| | |
| | |
| | |
| | |
| | |
| | |

| | | | |
|----------------|----------|-------------|-------------|
| EDITION | A | PAGE | 2/10 |
|----------------|----------|-------------|-------------|

ELECTRICAL PERFORMANCE / 電器性能

1.SAFETY STANDARD / 安規標準

- 1.1 The green mode power supply shall be certified by the following international regulatory standards: 充電器應符合下列的國際標準：

| Certificate 證書 | Country 國家 | Standard/安規標準 | Certificate 證書 | Country 國家 | Standard/安規標準 |
|--|------------------|---|---|---------------|--|
| <input checked="" type="checkbox"/> UL/cUL | USA/CA 北美 | UL62368-1; | <input checked="" type="checkbox"/> FCC | USA | FCC Part 15 Sub-part B |
| <input checked="" type="checkbox"/> LVD / UKCA | Eu / UK 欧盟 英国 | BS EN 62368-1:2014+A11:2017 | <input checked="" type="checkbox"/> CE | Europe 歐洲 | EN55032;EN55035; EN55024;EN61000; EN55022; |
| <input checked="" type="checkbox"/> CB | Global 全球 | IEC62368;IEC61558; IEC60335;IEC60529 | <input checked="" type="checkbox"/> KC | Korea 韓國 | K60950-1 |
| <input checked="" type="checkbox"/> PSE | Japan 日本 | J62368;J60335 | <input checked="" type="checkbox"/> SAA/RCM | AU 澳洲 | AS/NZS 62368.1:2018 SAA-211032-EA |
| <input checked="" type="checkbox"/> GS | Germany 德国 | EN 62368-1:EN61558 EN 60335 | <input type="checkbox"/> CCC | CN 中國 | GB 17625.1-2012;GB 4943.1-2011 |

2.INPUT FEATURE / 輸入特性

- 2.1 INPUT VOLTAGE RANGE: 90Vac to 264Vac. 輸入電壓範圍可以從90Vac到264Vac.
- 2.2 RATED INPUT VOLTAGE: 100Vac to 240Vac. 額定輸入電壓從100Vac到240Vac.
- 2.3 INPUT FREQUENCY RANGE: 47Hz to 63Hz. 輸入頻率範圍從47Hz到63Hz.
- 2.4 INPUT CURRENT: 3.0A max.&100-240Vac. 最大輸入電流3.0A (輸入條件100-240Vac)
- 2.5 INRUSH CURRENT: 45A max. at 100-240Vac input for a cold start at 25°C. 在准開機條件下，最大浪湧電流不超過45A (輸入條件100-240Vac).
- 2.6 EFFICIENCY: higher than 88% at 100-240Vac input and output full load. 效率高於88% (輸入100-240Vac 和輸出滿載條件)。
- 2.7 No-Load Input Power Dissipation/輸入空載功率損耗：Input 115Vac or 230Vac,output no load, the input power loss is less than 0.21W. 輸入115/230V交流，在空載時，輸入功耗

3.OUTPUT/輸出特性

| RATED OUTPUT / 額定輸出 | SPEC. LIMIT / 規格限定 | | REMARK / 備註 |
|-----------------------------|--------------------|------------|--|
| | Min. value | Max. value | |
| Output regulation / 輸出電壓規格 | 22.8VDC | 25.2VDC | 24V±5% |
| Output load / 輸出負載規格 | 0.0A | 5A | Peak Current:6A |
| Ripple and Noise / 輸出紋波及雜訊 | — | <200mVp-p | 20MHz Bandwidth 10uF Ele. Cap.& 0.1uF Cer. Cap |
| Output Overshoot / 輸出過沖幅度 | — | 10% | |
| Line regulation / 電壓調整率 | — | ±1% | |
| Load regulation / 負載調整率 | — | ±3% | |
| Turn-on delay time / 開機延遲時間 | — | 3000mS | |
| Hold up time / 關機維持時間 | 10mS | — | Input voltage:115Vac |
| | 20mS | — | Input voltage:230Vac |

| | | | |
|----------------|----------|-------------|-------------|
| EDITION | A | PAGE | 3/10 |
|----------------|----------|-------------|-------------|

ELECTRICAL PERFORMANCE / 電器性能

4.4 IELECTRIC WITHSTANDING STRENGTH(HI-POT) / 絕緣介電強度 (耐壓)

Primary to Secondary AC3000V, 10mA, 1 minute for type test, 3 second for production.
一次側對二次側：AC3000V, 10mA標準測試1分種，量產測試3秒鐘。

5.PROTECTION FEATURE / 保護特性

5.1 OVER—CURRENT PROTECTION / 過電流保護：

The green mode power supply shall be hiccup when any output operating in overload condition(set@ Max load 120~180%) under any line condition for an indefinite period of time. The power supply shall be self — recovery when the fault condition is removed. 在任何時候任何輸入條件，當輸出操作在超載條件最大電源的（120~180%）時，電源供應器將進入打嗝模式，當故障被移走後，電源要能自動恢復到正常。

5.2 SHORT—CIRCUIT PROTECTION / 輸出短路保護：

The power supply shall be hiccup and no damage shall occur when any output operating in a short circuit condition under any line condition for an indefinite period of time. The power supply shall be self—recovery when the fault condition is removed. 在任何時候，任何輸入條件下，當輸出操作在短路情況下，電源供應器將進入打嗝模式，當故障消失後，電源要能自動恢復正常。

6.ENVIRONMENTAL CONDITIONS / 環境條件

6.1 OPERATING / 操作條件：

The power supply shall be capable of operating continuously in any mode without performance deterioration in the following environmental conditions. 在下列環境條件下，電源供應器要能夠連續操作在各種模式，且不能造成性能的退化。

6.1.1 **Operating Temperature: -20°C~40°C 工作溫度：-20°C~40°C**

6.1.2 **Relative Humidity: 10%~90% 相對濕度：10%~90%**

6.1.3 **Vibration: 1.0mm, 10—25Hz, 15 minutes per cycle for each axis (X, Y, Z)**

6.1.4 **Cooling: The power supply will operate with convection cooling. Blocking of vents must not cause damage to the power supply. 電源供應器將操作在對流冷卻的環境下，即使將通風口阻塞電源也不允許有任何損傷發生。**

6.2 NON—OPERATING / 非操作條件：

The power supply shall be capable of withstanding the following environmental conditions extended periods of time, without sustaining electrical or mechanical damage and subsequent operational deficiencies.

電源供應器要能夠長期的經受下列的環境條件，且不允許有電氣級機械方面的損傷和併發的操作的缺失

6.2.1 **Storage Temperature: -30°C~70°C 儲存溫度：-30°C~70°C**

6.2.2 **Relative Humidity: 10%~90%相對濕度：10%~90%**

6.2.3 **Color of case and cable / 外殼及線材顏色：Black / 黑色**

| | | | |
|----------------|----------|-------------|-------------|
| EDITION | A | PAGE | 4/10 |
|----------------|----------|-------------|-------------|

ELECTRICAL PERFORMANCE / 電器性能

6.2.4 Vibration and Shock / 振動和衝擊

The power supply shall be designed to withstand normal transportation vibration per MIL—STD—810D,method 514 and procedures X, as it s mounted in the chassis assembly and packed for shipping.

電源供應器出貨的包裝設計，均要能承受正常運輸的振動，並符合MIL—STD—810D方法514 和程式 X。

7.EMC STANDARDS / 電磁相容性標準

7.1 EMI STANDARDS / EMI 標準

The power supply met the radiated and conducted emission requirements for FCC CLASS B, EN55032 CLASS B.

本電源供應器符合輻射及傳導要求，滿足FCC CLASS B, EN55032 CLASS B.

7.2 EMS STANDARDS / EMS 標準

The power supply shall meet the following EMS standards: 本電源供應器滿足下列EMS標

7.2.1 EN61000-4-2: 2009 / A1: 1998 Electrostatic Discharge(ESD)

7.2.2 EN61000-4-3: 2010 / A1: 1998 Radiated Electromagnetic Fields(RS)

7.2.3 EN61000-4-4: 2012 Electrical Fast Transient / Burst(EFT)

7.2.4 EN61000-4-5: 2014 Lighting Surge Attachment. Line to Neutral: 2KV

8 RELIABILITY AND QUALITY CONTROL / 可靠性及品質控制

8.1 BURN—IN / 老化

The power supply shall undergo a minimum of 4 hours Burn—In test under full load at 40^o

電源應在40℃~±5℃和滿載條件下老化4小時。

8.2 COMPONENT DERATING / 元件溫度要求

Semiconductor junction temperatures shall not exceed the manufacturer's maximum thermal rating. 半導體結溫不允許超過其製造商要求的最大溫度值。

9.WEIGHT / 重量

The weight of the power supply shall be about 500g 電源的重量大約為500g。

10.MECHANICAL REQUIREMENT / 結構參數

The power supply size: L153*W61*L39mm.外殼尺寸: L153*W61*L39mm

11.INSULATION RESISTANCE / 絕緣阻抗

Input to output: 50M OHM(500VDC)輸入對輸出50兆歐姆 (500VDC)

| | | | |
|---------|---|------|------|
| EDITION | A | PAGE | 5/10 |
|---------|---|------|------|

ELECTRICAL PERFORMANCE / 電器性能

12.LEAKAGE CURRENT / 漏電流

The leakage current shall be **less than 0.25mA for class II** when power supply is operated maximum input voltage and maximum load. 當電源供應器操作在最大輸入及最大負載情況下，其漏電流應**小於0.25mA, 滿足class II等級**。

13.MAJOR MEASURE EQUIPMENT / 主要測量設備; VERIFIED BY THE THIRD LAB/外校

- A AC SOURCE / AC變頻電源: 固緯/GWINSTEK APS-7100E,校準頻次: 1次/年 ✓
- B DIGITAL POWER METER / 數字功率計功率儀: 固緯/GWINSTEK GPM-8213,校準頻次: 1次/年 ✓
- C ELECTRONIC LOAD / 開編程電子負載儀: 美爾諾/MAYNUO M9713,校準頻次: 1次/年 ✓
- D OSCILLOSCOPE / 存儲示波器: 泰科/TEKTRONIX TBS1102B,校準頻次: 1次/年 ✓
- E DIGITAL MULTIMETER / 數字式萬用表: 福祿克(FLUKE) F12E+校準頻次: 1次/年 ✓
- F DC POWER / 直流電源: 麥創 (MATRIX) MPS-6030D校準頻次: 1次/年 ✓
- G HIPOT AND INSULATION RESISTANCE TESTER / 耐壓安規測試儀: ✓
固緯/GWINSTEK GPT-9803 ,校準頻次: 1次/年
- H NSULATION RASISTANCE TESTER / 絕緣電阻表: YD2681A,校準頻次: 1次/年 ✓
- I MULTI CHANNEL TEMPERATURE SENSOR / 多路溫度測試儀 ✓
艾維泰科/IVYTECH IV380-16校準頻次: 1次/年

| | | | |
|---------|---|------|------|
| EDITION | A | PAGE | 6/10 |
|---------|---|------|------|

DC CORD / 輸出線材

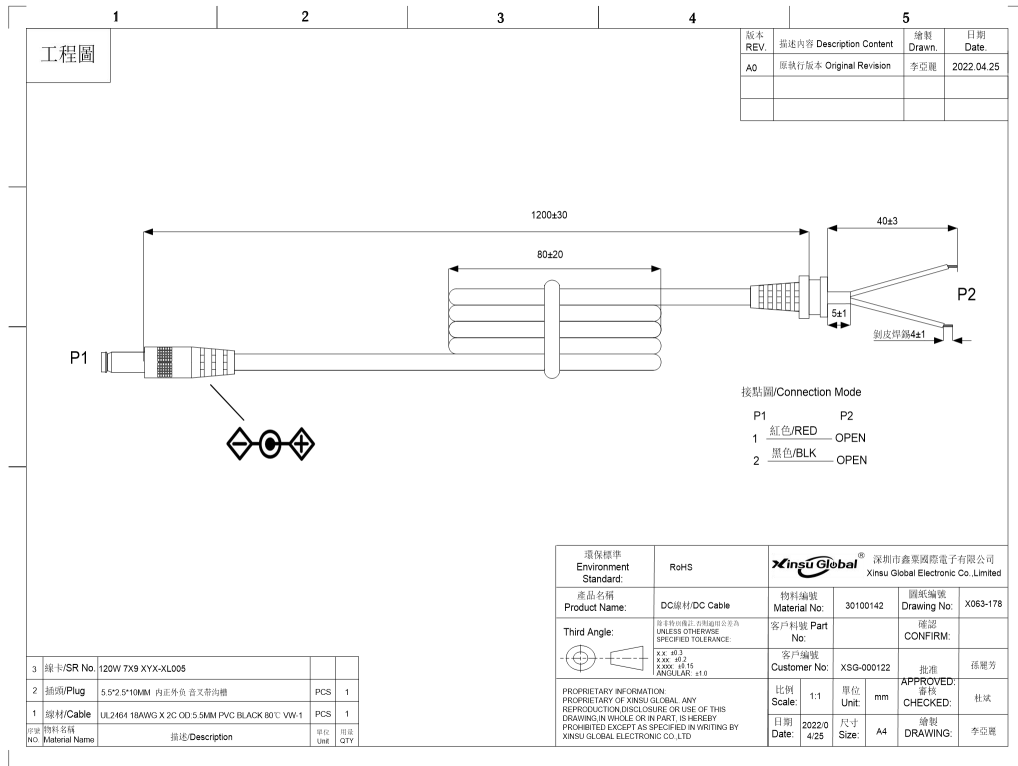

| Cable Specification/線材規格 | | |
|--|------------------------------|----------------------------|
| UL2464 Round Wire, 18AWG*2C L=1.2M Black 80°C,300V | | |
| Item No | Part Name (部件名稱) | Description (描述) |
| A | Length of DC cord(DC線長度) | 1.2M |
| B | Size of DC connector (DC頭尺寸) | 5.5*2.5*10mm直頭內正外負, 音叉帶溝槽。 |
| C | Length of coil (線包長度) | 70MM±10 |
| D | SR NO(線卡編號) | XYX-XL005 |
| E | Length of inlet wire (出線長度) | 30MM±1 |
| F | Tinned length (吃錫長度) | 4MM±1 |

| | | | |
|---------|---|------|------|
| EDITION | A | PAGE | 7/10 |
|---------|---|------|------|

AC CORD/输入线材

| | | |
|-----------------------|--------------|--|
| Version: 版本: A | Customer: 鑫聚 | 本册适用材料加工公差表 尺寸范围 公差尺寸 1~6 ±1 6.1~10 ±2 10.1~20 ±3 20.1~50 ±4 50.1~100 ±8 100.1~1000 ±15 1000.1~4000 ±40 >4000 ±100 本册适用材料环境要求 REACH |
| Drawing NO: 图号 X16001 | Customer: 鑫聚 | |
| Customer P/N: ACH电源线 | 密1 | |

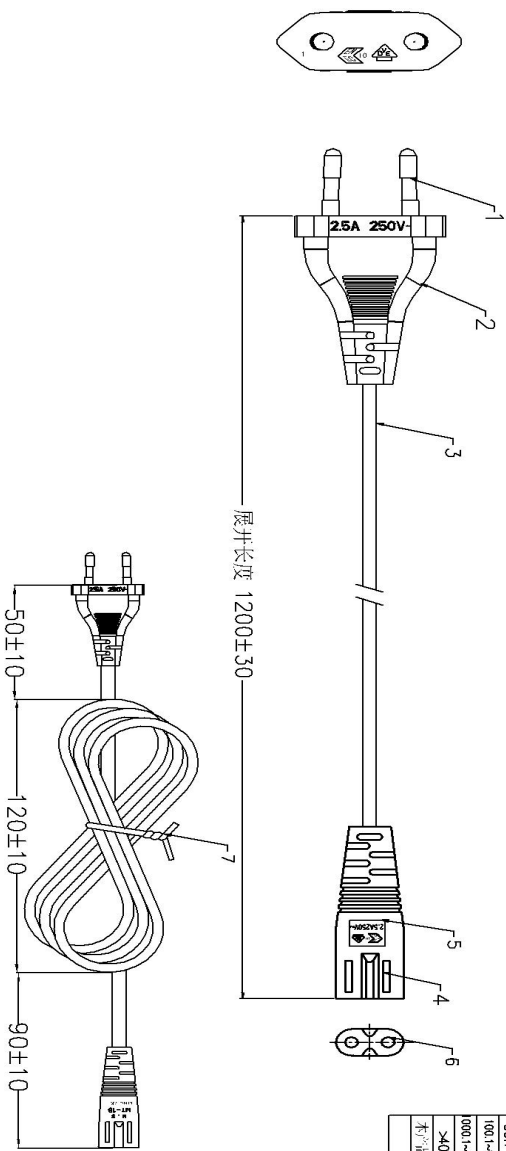



| | | | | | | | |
|----------|---|-------------------------|------------|-------------|--------|---------|-----------|
| 线材 印字 | KEMA-KEUR VDE REC 60227-5 300/300V H03VH2-F 2X0.75mm ² CABO FLEXIVEL PLANO IEMMEQU + + + + + N14440 NEW SQUARE | 油印 凹印 | ✓ | | | | |
| 7 | 导线 (Wire & cable) | 黑色 | 包PVC绝缘线 | 1 | 140 | | |
| 6 | 插座端子 (Terminal of end plug) | | Ø2.35 葫芦铜管 | 2 | | 磷铜色 | |
| 5 | 插座脚套 (Type of end plug) | MT-18<2.5A 250V>ENEC> | BK001 | 89A PVC | 1 | | 黑色 |
| 4 | 尾帽衬套 | | 黑色 | 八字型衬套 | 1 | | |
| 3 | 线材绝缘 (Cord specification) | VDE H03VH2-F 2X0.75mmSQ | BK001 | 80A PVC | 1 | 1185-28 | 黑色 |
| 2 | 插头型式 (Type of plug) | MT-11<2.5A 250V>ENEC> | BK001 | 89A PVC | 1 | | 黑色 |
| 1 | 插头五金 (Pin of plug) | 欧式架五金 | 黑色 | | 1 | | 镀锌 |
| ITEM | NAME 名称 | SPECIFICATION 型号 / 规格 | COLOR 颜色 | MATERIAL 材质 | QTY 数量 | SIZE 尺寸 | REMARK 备注 |

| | | |
|-------------|------------|------------|
| 标题: 名称 | Draw: ZHAN | 2015-10-06 |
| PLUG & WIRE | 绘图 | |
| Unit: mm | 单位 | |
| 批准 | 核准 | |
| 更改内容 | 工程 | 签字 日期 |

赣州永德电业制品有限公司

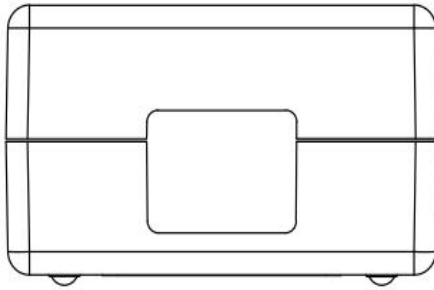
PRODUCT OUTLINE DIMENSION / 產品外觀尺寸

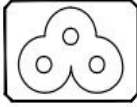

| | | | |
|---------------|--|---|---|
| AC Inlet Type | IEC 320-C6 | IEC 320-C14 | IEC 320-C8 |
| AC入力コネクタ |  |  |  |
| AC輸入類型 | | | <input checked="" type="checkbox"/> |

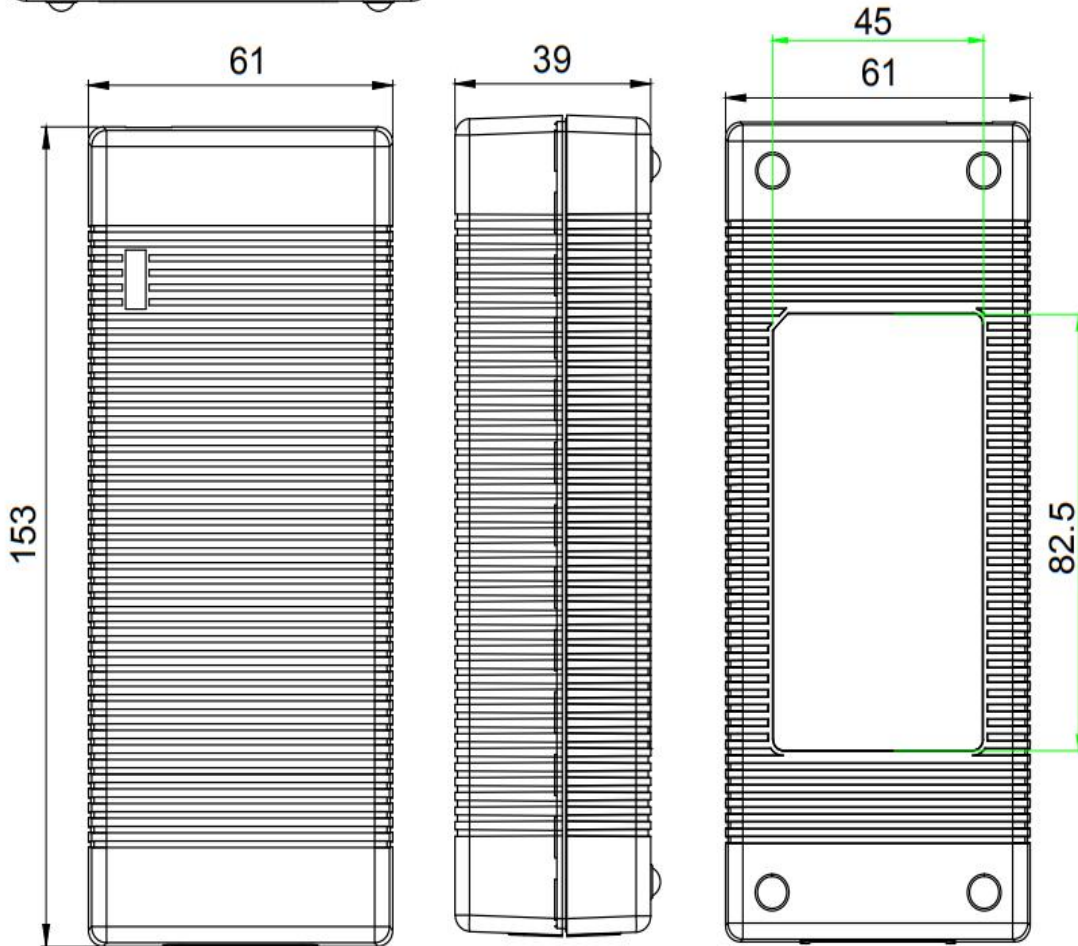

Material/材料: PC

Brand/品牌: SABIC / 沙伯

Fireproof Class/防火等級: UL94V-0

Color/顏色: Black/黑色

| | | | |
|----------------|----------|-------------|-------------|
| EDITION | A | PAGE | 9/10 |
|----------------|----------|-------------|-------------|

RATING LABEL / 銘牌

Xinsu Global®

SWITCHING POWER SUPPLY
(スイッチング電源)

MODEL(品番): XSG2405000
 INPUT(入力): 100-240V~50/ 60Hz 3.0A
 OUTPUT(出力): 24.0V \equiv 5.0A 120.0W 













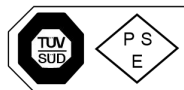













Xinsu Global 株式会社



직류전원장치
 부품명: XSG2405000
 정격입력: 100-240 V~, 50/60 Hz, 2.5 A
 정격출력: 24.0V \equiv 5.0A 120.0W
 HU10934-20005B A/S: 02-926-9084

ROHS

 EFFICIENCY

CAUTION:
RISK OF ELECTRIC SHOCK
DRY LOCATION USE ONLY
 乾燥している場所でのみ使用してください

MADE IN CHINA DATE CODE: XXXXXX
 XINSU GLOBAL ELECTRONIC CO., LIMITED

标贴仅供参考

Print/印刷

Laser Carving/鐫雕

1. Silver text on black background 黑底銀字
2. Material: PET 底材為消銀龍.
3. Clear Printing, Wipe Resistance 絲印清晰，耐擦拭.
4. Gum Permanent 永久背膠.
5. Meet Requirements of Environmental Protection 符合環保要求

| | | | |
|----------------|----------|-------------|--------------|
| EDITION | A | PAGE | 10/10 |
|----------------|----------|-------------|--------------|